

Part Name	
1	Body
2	Seat
3	Disc
4	Bonnet
5	Packing
6	Gland
7	Tstud, Nut
8	Stem
9	Gasket
10	Stud, Nut
11	Hand wheel
12	Spring

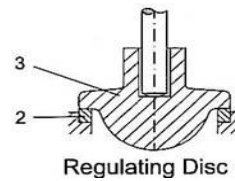

DN	15	20	25	32	40	50	65	80	100	125	150	175	200	250	300	350	400	500	600
L	130	150	160	180	200	230	290	310	350	400	480	550	600	730	850	980	1100	1250	1450
H (Open)	170	170	176	176	230	240	258	315	356	454	516	598	598	830	910	985	1085	1250	-
ØR	120	120	140	140	160	160	180	200	220	250	300	400	400	400	520	520	520	640	640
Weight (Kg)	4	4,5	5,5	7	11	13	18	24	34	56	95	110	138	220	287	440	534	1020	-

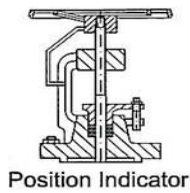
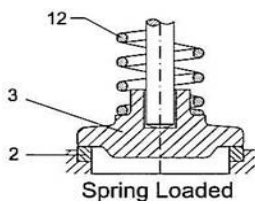
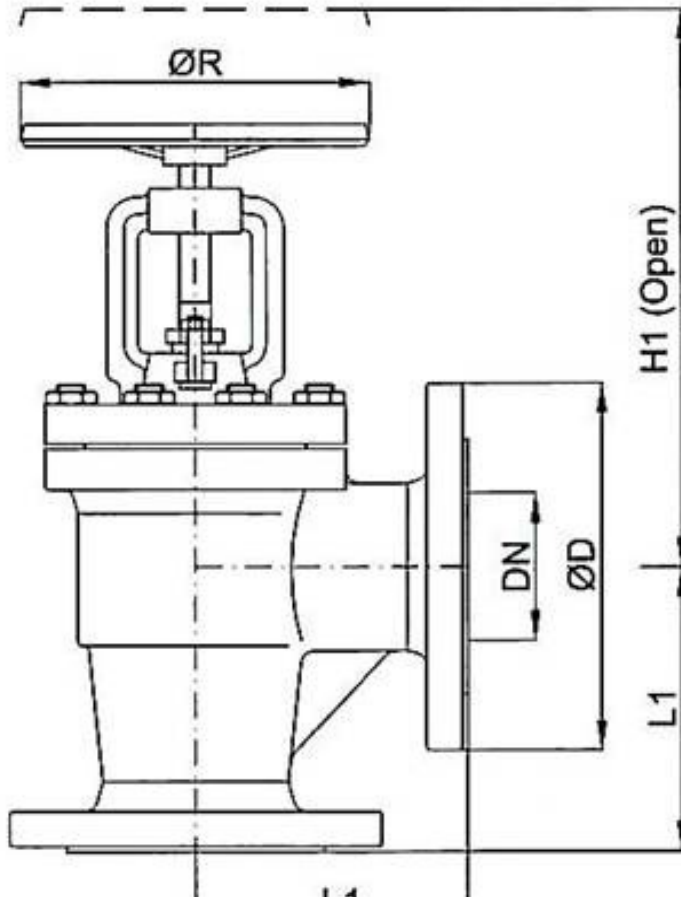
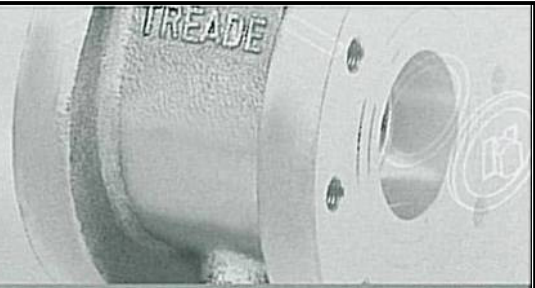

Part Name	
1	Body
2	Seat
3	Disc
4	Bonnet
5	Packing
6	Gland
7	Tstud, Nut
8	Stem
9	Gasket
10	Stud, Nut
11	Hand wheel
12	Spring

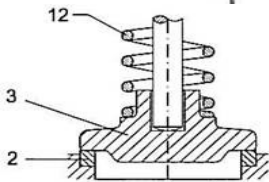

Spring Loaded

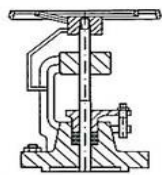

Position Indicator

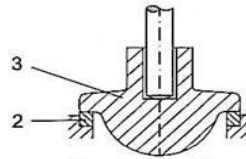

Regulating Disc



DN	15	20	25	32	40	50	65	80	100	125	150	175	200	250	300	350	400	500	600	
L1	90	95	100	105	115	125	145	155	175	200	225	250	275	325	375	425	475	525	450	
(Open)																			550	
H1	160	160	166	170	212	223	240	210	320	410	450	512	512	705	785	885	954	1100	1355	
(Open)																				
ØR	120	120	140	140	160	160	180	200	220	250	300	400	400	400	520	520	520	640	640	
Weight (KG)	4,5	5	6	7	11	12	17	24	34	53	65	95	111	191	252	375	375	770	940	